

JAL-OIS15-FF-OV5648**5MP OmniVision OV5648 OIS MGS MIPI Interface Fixed Focus Camera Module**

Front View



Back View

Specifications

Camera Module No.	JAL-OIS15-FF-OV5648
Resolution	5MP
Image Sensor	OV5648 w/ MGS OIS
Sensor Type	1/4"
Pixel Size	Fixed Focus
EFL	3.63 mm
F.NO	1.80
Pixel	2592 x 1944
View Angle	65.0°(DFOV)
Lens Dimensions	15.40 x 15.40 x 4.50 mm
Module Size	35.50 x 15.40 mm
Module Type	Fixed Focus
Interface	MIPI
Auto Focus VCM Driver IC	None
Lens Type	650nm IR Cut
Operating Temperature	-30°C to +70°C
Mating Connector	BAF04-30083-0500



JAL-OIS15-FF-OV5648

5MP OmniVision OV5648 OIS MGS MIPI Interface Fixed Focus Camera Module



Top View



Side View



Bottom View



Mating Connector

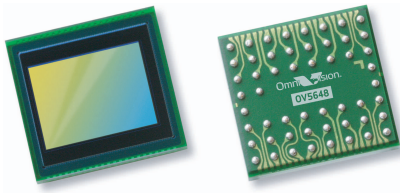

OV5648 5-megapixel product brief



Cost-Efficient 5-Megapixel Camera Solution for Mainstream Mobile Devices



available in
a lead-free
package

The OV5648 is a cost-efficient, high performance 5-megapixel CameraChip™ sensor for smartphones and tablets. Utilizing OmniVision's latest 1.4-micron OmniBSI+™ pixel architecture, the OV5648 combines a reduced die size with improved quality photography and high-definition (HD) video, making it ideally suited for mainstream mobile applications.

OmniVision's powerful new OmniBSI+ pixel architecture offers significant performance improvements over our original OmniBSI™ architecture, including a 60 percent increase in full-well capacity and a significant improvement in low-light sensitivity. With OmniBSI+, the 1/4-inch OV5648 is capable of capturing high quality still images as well as 720p HD video at 60 frames per second (fps) and 1080p HD video at 30 fps.

The sensor supports a two-lane MIPI interface, and provides full-frame, windowed or binned 10-bit images in RAW RGB format with complete user control over

formatting and output transfer. It offers defective pixel canceling and all required automatic image control functions, including automatic exposure control, automatic gain control, automatic white balance, and automatic black level calibration.

A secondary image sensor may be connected to the OV5648 enabling a Video-in-Video (ViV) feature in which the secondary image is overlaid to the OV5648 output video. The combined video is streamed out over the MIPI interface. A bypass mode allows a secondary sensor to utilize the OV5648 MIPI interfaced baseband.

The OV5648 can fit into a 6 x 6 mm fixed focus camera module with a z-height of less than 4.5 mm.

Find out more at www.ovt.com.

Applications

- Cellular and Picture Phones
- PC Multimedia
- Toys
- Digital Still Cameras

Product Features

- 1.4 μm x 1.4 μm pixel with OmniBSI™ technology for high performance (high sensitivity, low crosstalk, low noise)
- optical size of 1/4"
- automatic image control functions:
 - automatic exposure control (AEC)
 - automatic gain control (AGC)
 - automatic white balance (AWB)
 - automatic black level calibration (ABLC)
- programmable controls for frame rate, AEC/AGC 16-zone size/position/weight control, mirror and flip, cropping, windowing, and panning
- defective pixel canceling
- support for output formats: 8-/10-bit raw RGB data
- support for video or snapshot operations
- support for LED and flash strobe mode
- support for internal and external frame synchronization for frame exposure mode
- support for horizontal and vertical sub-sampling
- standard serial SCCB interface
- MIPI interface (two lanes)
- Video-in-Video (ViV) and bypass support for secondary sensor
- 32 bytes of embedded one-time programmable (OTP) memory
- on-chip phase lock loop (PLL)
- embedded 1.5V regulator for core power
- programmable I/O drive capability, I/O tri-state configurability
- support for black sun cancellation

OV5648

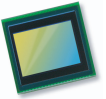

Ordering Information

- OV05648-A53A**
(color, lead-free, 53-pin CSP3)
- OV05648-G04A**
(color, chip-probing, 200 μm backgrinding, reconstructed wafer)

Product Specifications

- active array size:** 2592 x 1944
- max S/N ratio:** 36 dB
- power supply:**
 - core: 1.5V \pm 5% (with embedded 1.5V regulator)
 - analog: 2.6 - 3.0V (2.8V typical)
 - I/O: 1.7 - 3.0V
- power requirements:**
 - active: 219 mW
 - standby: 36 μW
- temperature range:**
 - operating: -30°C to 70°C junction temperature
 - stable image: 0°C to 50°C junction temperature
- output formats:** 8-/10-bit RGB RAW output
- lens size:** 1/4"
- lens chief ray angle:** 29.1°
- input clock frequency:** 6 - 27 MHz
- dynamic range:** 72 dB @ 8x gain
- maximum image transfer rate:**
 - QSVGA (2592x1944): 15 fps
 - 1080p: 30 fps
 - 960p: 45 fps
 - 720p: 60 fps
 - VGA (640x480): 90 fps
- sensitivity:** 690 mV/lux-sec
- shutter:** rolling shutter
- pixel size:** 1.4 μm x 1.4 μm
- dark current:** 0.7 mV/s @ 50°C junction temperature
- image area:** 3673.6 μm x 2738.4 μm
- package/die dimensions:**
 - CSP3: 5010 μm x 4810 μm
 - COB: 5000 μm x 4800 μm

Functional Block Diagram

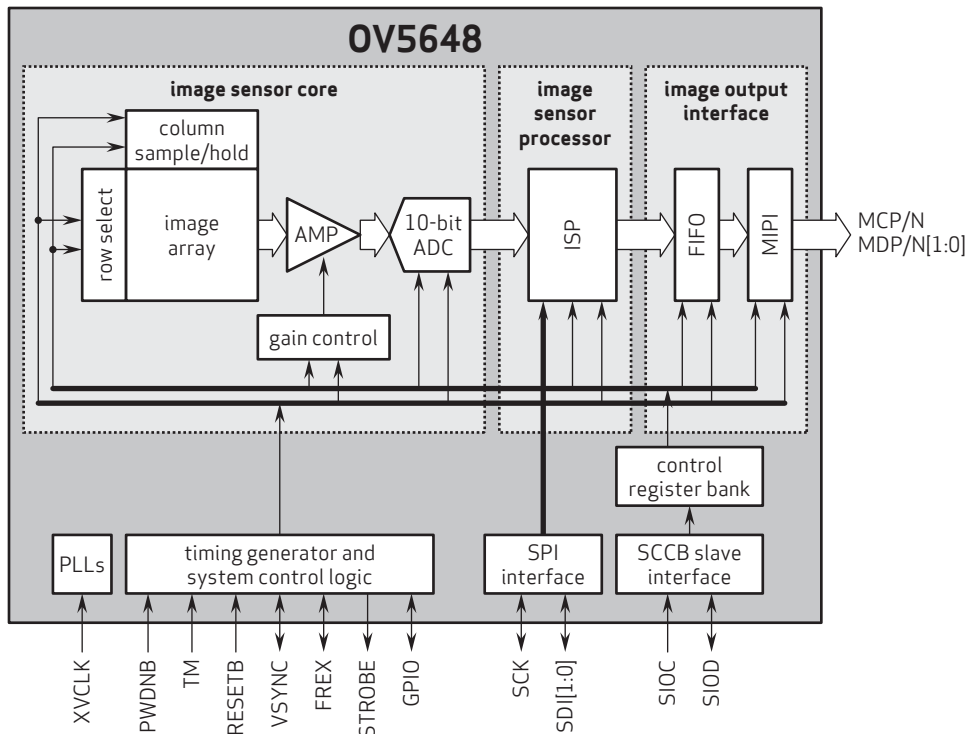

4275 Burton Drive
Santa Clara, CA 95054
USA

Tel: +1 408 567 3000
Fax: +1 408 567 3001
www.ovt.com

OmniVision reserves the right to make changes to their products or to discontinue any product or service without further notice. OmniVision, the OmniVision logo and VarioPixel are registered trademarks of OmniVision Technologies, Inc. CameraChip and OmniBSI+ are trademarks of OmniVision Technologies, Inc. All other trademarks are the property of their respective owners.





Micro Gimbal Stabilizer (MGS) OIS Camera Modules

Micro Gimbal Stabilizer (MGS) is the patented mechanical optical image stabilizer (OIS) for camera modules. The MGS technology is tilting the image sensor and lens together, enabling anti-shaking performance for moving devices to take a sharp and clear image, even in the low light environment.



Features

2-Axis Compensation
Small, Light Weight
18.80x18.80x15.80mm



Smallest Gimbal



Multi-Axis Compensation

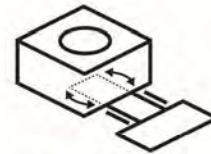

Embedded Moving FPC



One-stop Solution

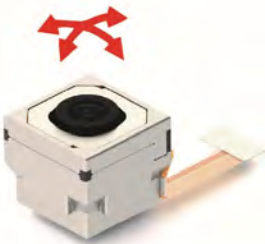

Stabilizer



Max. View Angle



Integrated Design



Patents

Applications



5G Smart Helmet



Sport Camera



Drones



Robots



Wearable Cameras



Micro Gimbal Stabilizer (MGS) for Mobile Phones

Micro Gimbal Stabilizer (MGS) is fitting in the compact size, enabling the smartphones and tablet PC to take clear images in the moving environment.

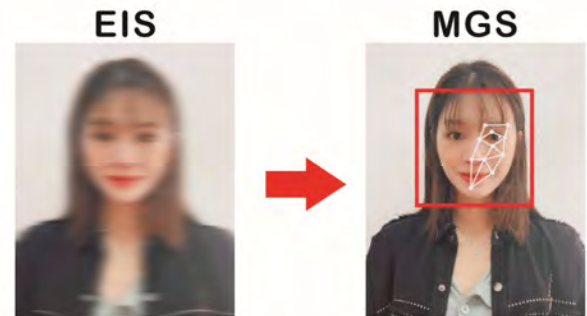
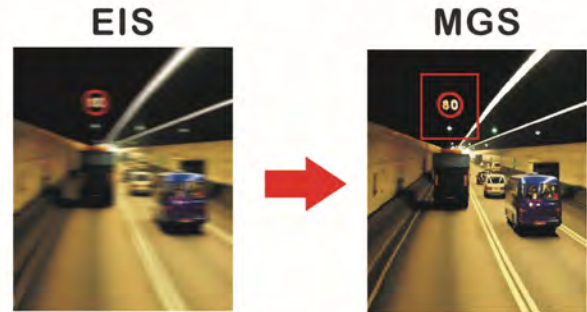
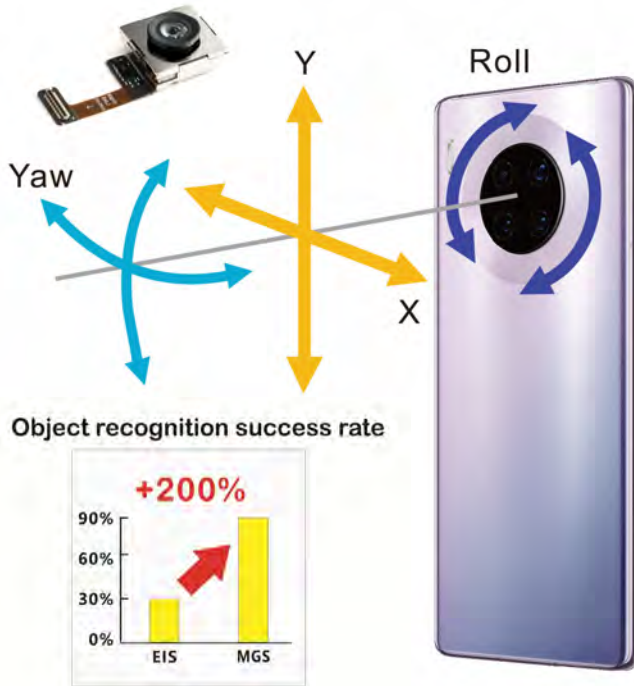



REV.	Q'TY	ECN. NO.	APR.	DATE
A	--	RC-12-2-019	Juson Su	2012.08.07

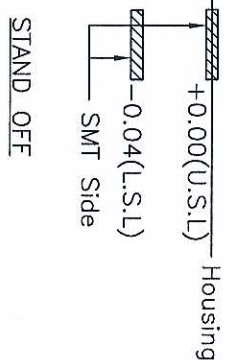
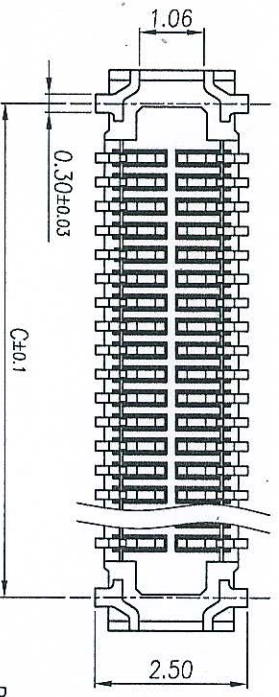
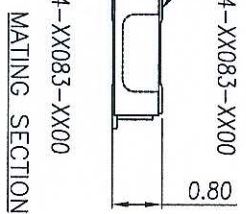
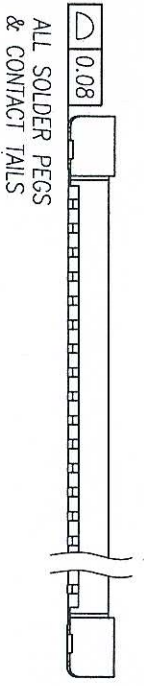
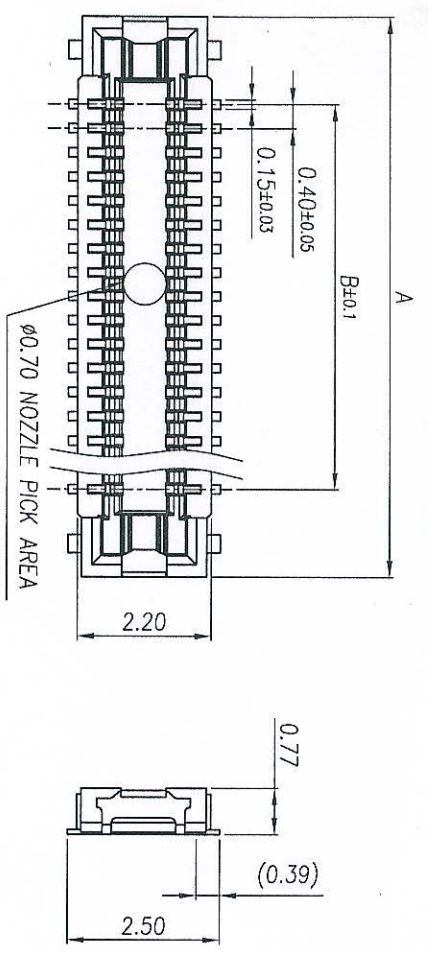
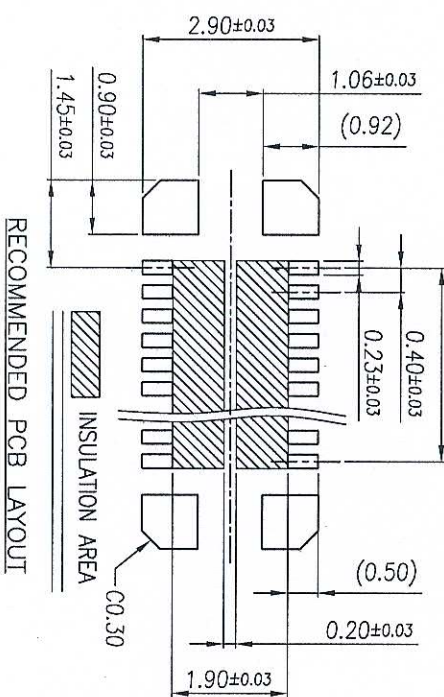
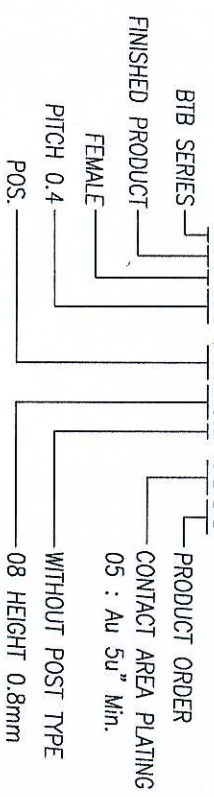

TABLE:

60	14.50	11.60	13.40	
50	12.50	9.60	11.40	
40	10.50	7.60	9.40	
34	9.30	6.40	8.20	
30	8.50	5.60	7.40	⊙
26	7.70	4.80	6.60	
24	7.30	4.40	6.20	⊙
20	6.50	3.60	5.40	
16	5.70	2.80	4.60	
10	4.50	1.60	3.40	⊙
Pos No:	A	B	C	Available



- NOTES:
- MATERIAL:
 - 1-1.HOUSING: THERMOPLASTIC,U94 V-0,BLACK;
 - 1-2.CONTACT: COPPER ALLOY, T=0.08mm
 - FINISH:
 - 2-1.CONTACT: Au 5u" MIN PLATING ON CONTACT AREA, Au 1u" MIN. PLATING ON SOLDER TAIL, 50u" MIN. NICKEL UNDERPLATING OVER ALL
 - PRODUCT SPECIFICATIONS:
 - 3-1.VOLTAGE RATING: 60V AC/DC
 - 3-2.CURRENT RATING: 0.3A/CONTACT(MAX. 5A AT TOTAL CONTACT)
 - 3-3.INSULATION RESISTANCE: 100MEG.OHM MIN(INITIAL)
 - 3-4.WITHSTANDING VOLTAGE: 150V AC FOR 1 MINUTE
 - 3-5.CONTACT RESISTANCE: 70 MILL.OHM MAX PER PIN INITIAL, AFTER CONDITION ΔR=20 MILL.OHM Max.
 - 3-6.OPERATION TEMPERATURE: -55° TO +85°
 - 3-7.MATING FORCE: 120g Max./POS.
 - 3-8.UNMATING FORCE: 15g Min./POS.
 - 3-9.DURABILITY: 30 CYCLES
 - PART NO: BAF04-XX083-0500



DIMENSION IN mm		TOLERANCE UNLESS OTHERWISE SPECIFIED	
.X± 0.35	X± 5'	APR.	
.XX± 0.25	X± 3'	CHK.	
.XXX± 0.15	.XX± 1'	DRA Kevin Wang	2012.08.07

LCN Shenzhen Linkconn Electronics Co.,Ltd.

TITLE: 0.4mm PITCH BTB FEMALE MATING HEIGHT 0.8mm

DWG NO: BAF04-24083-0500

PROJ. SCALE N/A SHEET 1/2 CUSTOMER DRAWING

REV. A

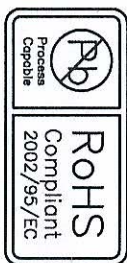

REV.	QTY	EQN. NO.	APR.	DATE
A	--	RC-12-2-019	Jason Su	2012.08.07

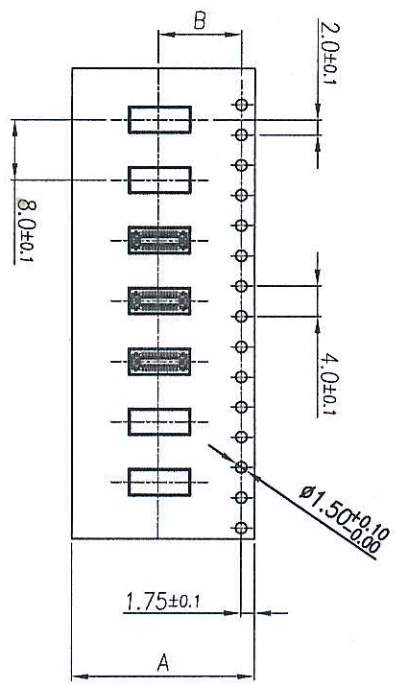
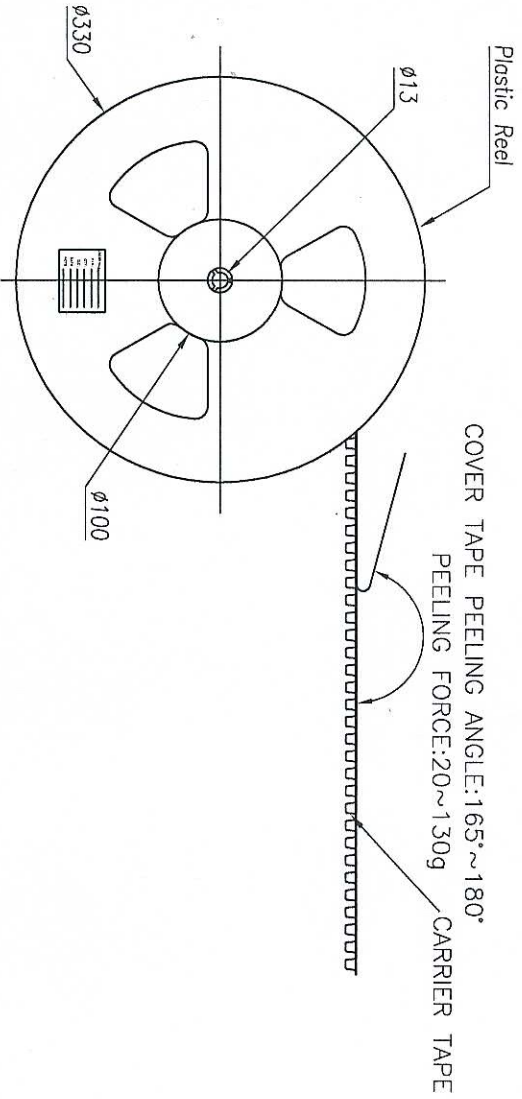
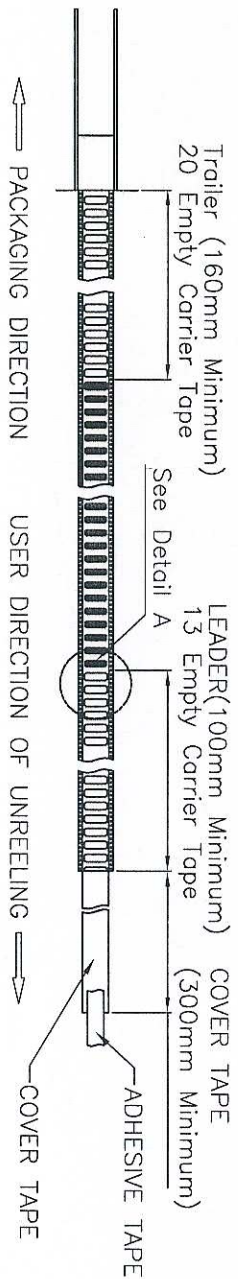

POS NO	DIM A	DIM B	QTY/REEL	REEL/CARTON	QTY/CARTON	CARTON SIZE
60						
50						
40	24.00	11.50	3000	10	30000	340*340*330
30						
26						
24						
20						
16	16.00	7.50	3000	14	42000	340*340*330
10						

DIMENSION IN mm		TOLERANCE UNLESS OTHERWISE SPECIFIED	
X±	0.35	X:±	1.5'
.XX±	0.25	.X:±	1.0'
.XXX±	0.15	.XX:±	0.5'

LCW Shenzhen Linkcomm Electronics Co., Ltd.

TITLE: 0.4mm PITCH BTB FEMALE MATING HEIGHT 0.8mm

DWG NO: BAF04-24083-0500

PROJ. SCALE N/A SHEET 2/2 CUSTOMER DRAWING

APR. CHK. DRN. Kevin Wang 2012.08.07



Cameras Applications



Automotive Driver Pilot



Live Streaming



Video Conference



Eye Tracker Biometric Detection

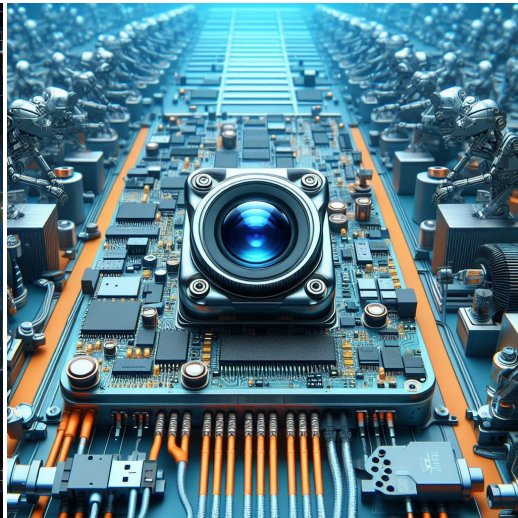

Machine Vision



Agricultural Monitor

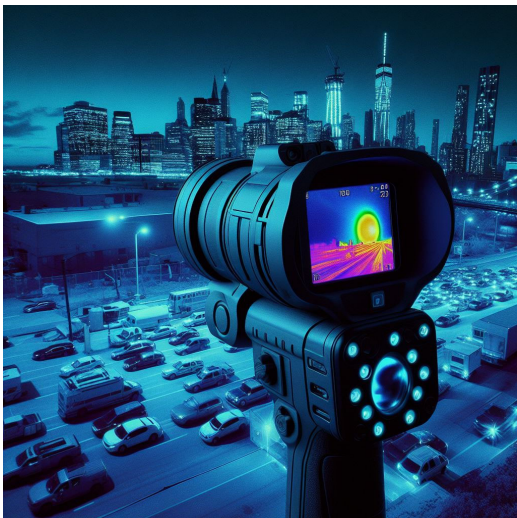

Night Vision Security



Drone and Sports Eagle Eyes



Interactive Pet Camera



your BEST camera module partner

Cameras Applications

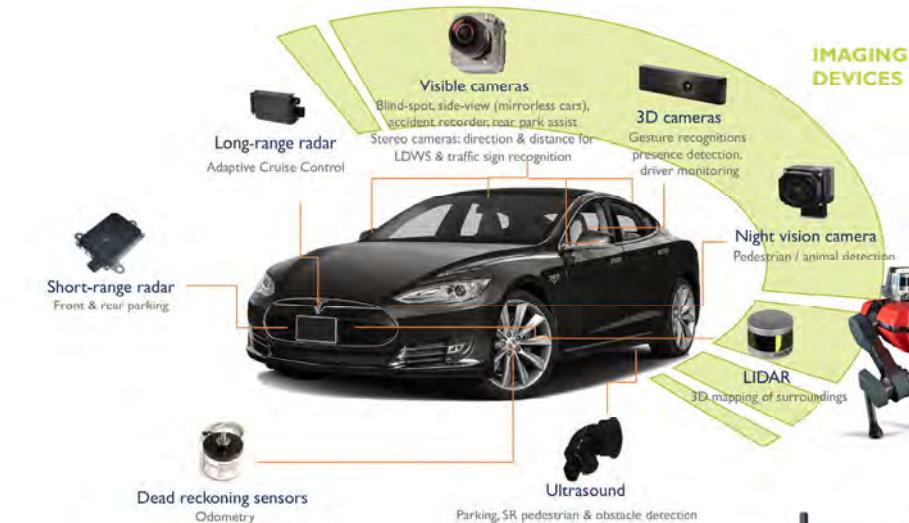

IMAGING DEVICES





Camera Module Pinout Definition Reference Chart

OmniVision	Sony	Samsung	On-Semi	Aptina	Himax	GalaxyCore	PixArt	SmartSens	Sensors	
Pin Signal										
Description										
DGND	GND									ground for digital circuit
AGND										ground for analog circuit
PCLK	DCK									DVP PCLK output
XCLR	PWDN	XSHUTDOWN	STANDBY							power down active high with internal pull-down resistor
MCLK	XVCLK	XCLK	INCK							system input clock
RESET	RST									reset active low with internal pull-up resistor
NC	NULL									no connect
SDA	SIO_D	SIOD								SCCB data
SCL	SIO_C	SIOC								SCCB input clock
VSYNC	XVS	FSYNC								DVP VSYNC output
HREF	XHS									DVP HREF output
DOVDD										power for I/O circuit
AFVDD										power for VCM circuit
AVDD										power for analog circuit
DVDD										power for digital circuit
STROBE	FSTROBE									strobe output
FSIN										synchronize the VSYNC signal from the other sensor
SID										SCCB last bit ID input
ILPWM										mechanical shutter output indicator
FREX										frame exposure / mechanical shutter
GPIO										general purpose inputs
SLASEL										I2C slave address select
AFEN										CEN chip enable active high on VCM driver IC
MIPI Interface										
MDN0	DN0	MD0N	DATA_N	DMO1N						MIPI 1st data lane negative output
MDP0	DP0	MD0P	DATA_P	DMO1P						MIPI 1st data lane positive output
MDN1	DN1	MD1N	DATA2_N	DMO2N						MIPI 2nd data lane negative output
MDP1	DP1	MD1P	DATA2_P	DMO2P						MIPI 2nd data lane positive output
MDN2	DN2	MD2N	DATA3_N	DMO3N						MIPI 3rd data lane negative output
MDP2	DP2	MD2P	DATA3_P	DMO3P						MIPI 3rd data lane positive output
MDN3	DN3	MD3N	DATA4_N	DMO4N						MIPI 4th data lane negative output
MDP3	DP3	MD3P	DATA4_P	DMO4P						MIPI 4th data lane positive output
MCN	CLKN	CLK_N	DCKN							MIPI clock negative output
MCP	CLKP	MCP	CLK_P	DCKN						MIPI clock positive output
DVP Parallel Interface										
D0	DO0	Y0								DVP data output port 0
D1	DO1	Y1								DVP data output port 1
D2	DO2	Y2								DVP data output port 2
D3	DO3	Y3								DVP data output port 3
D4	DO4	Y4								DVP data output port 4
D5	DO5	Y5								DVP data output port 5
D6	DO6	Y6								DVP data output port 6
D7	DO7	Y7								DVP data output port 7
D8	DO8	Y8								DVP data output port 8
D9	DO9	Y9								DVP data output port 9
D10	DO10	Y10								DVP data output port 10
D11	DO11	Y11								DVP data output port 11



Camera Reliability Test

Reliability Inspection Item		Testing Method	Acceptance Criteria	
Category	Item			
Environmental	Storage Temperature	High 60°C 96 Hours	Temperature Chamber	No Abnormal Situation
		Low -20°C 96 Hours	Temperature Chamber	No Abnormal Situation
	Operation Temperature	High 60°C 24 Hours	Temperature Chamber	No Abnormal Situation
		Low -20°C 24 Hours	Temperature Chamber	No Abnormal Situation
	Humidity	60°C 80% 24 Hours	Temperature Chamber	No Abnormal Situation
	Thermal Shock	High 60°C 0.5 Hours Low -20°C 0.5 Hours Cycling in 24 Hours	Temperature Chamber	No Abnormal Situation
Physical	Drop Test (Free Falling)	Without Package 60cm	10 Times on Wood Floor	Electrically Functional
		With Package 60cm	10 Times on Wood Floor	Electrically Functional
	Vibration Test	50Hz X-Axis 2mm 30min	Vibration Table	Electrically Functional
		50Hz Y-Axis 2mm 30min	Vibration Table	Electrically Functional
		50Hz Z-Axis 2mm 30min	Vibration Table	Electrically Functional
	Cable Tensile Strength Test	Loading Weight 4 kg 60 Seconds Cycling in 24 Hours	Tensile Testing Machine	Electrically Functional
Electrical	ESD Test	Contact Discharge 2 KV	ESD Testing Machine	Electrically Functional
		Air Discharge 4 KV	ESD Testing Machine	Electrically Functional
	Aging Test	On/Off 30 Seconds Cycling in 24 Hours	Power Switch	Electrically Functional
	USB Connector	On/Off 250 Times	Plug and Unplug	Electrically Functional





Inspection Item		Inspection Method	Standard of Inspection		
Category	Item				
Appearance	FPC/ PCB	Color	The Naked Eye	Major Difference is Not Allowed.	
		Be Torn/Chopped	The Naked Eye	Copper Crack Exposure is Not Allowed.	
		Marking	The Naked Eye	Clear, Recognizable (Within 30cm Distance)	
	Holder	Scratches	The Naked Eye	The Inside Crack Exposure is Not Allowed	
		Gap	The Naked Eye	Meet the Height Standard	
		Screw	The Naked Eye	Make Sure Screws Are Presented (If Any)	
		Damage	The Naked Eye	The Inside Crack Exposure is Not Allowed	
	Lens	Scratch	The Naked Eye	No Effect On Resolution Standard	
		Contamination	The Naked Eye	No Effect On Resolution Standard	
		Oil Film	The Naked Eye	No Effect On Resolution Standard	
		Cover Tape	The Naked Eye	No Issue On Appearance.	
	Function	Image	No Communication	Test Board	Not Allowed
			Bright Pixel	Black Board	Not Allowed In the Image Center
Dark Pixel			White board	Not Allowed In the Image Center	
Blurry			The Naked Eye	Not Allowed	
No Image			The Naked Eye	Not Allowed	
Vertical Line			The Naked Eye	Not Allowed	
Horizontal Line			The Naked Eye	Not Allowed	
Light Leakage			The Naked Eye	Not Allowed	
Blinking Image			The Naked Eye	Not Allowed	
Bruise			Inspection Jig	Not Allowed	
Resolution			Chart	Follows Outgoing Inspection Chart Standard	
Color			The Naked Eye	No Issue	
Noise			The Naked Eye	Not Allowed	
Corner Dark			The Naked Eye	Less Than 100px By 100px	
Color Resolution			The Naked Eye	No Issue	
Dimension	Height	The Naked Eye	Follows Approval Data Sheet		
	Width	The Naked Eye	Follows Approval Data Sheet		
	Length	The Naked Eye	Follows Approval Data Sheet		
	Overall	The Naked Eye	Follows Approval Data Sheet		



KLT Package Solutions

KLT Camera Module



Complete with Lens Protection Film



Tray with Grid and Space



Place Cameras on the Tray





Camera Modules Package Solution

Full Tray of Cameras



Cover Tray with Lid



Put Tray into Anti-Static Bag



Vacuum the Anti-Static Bag

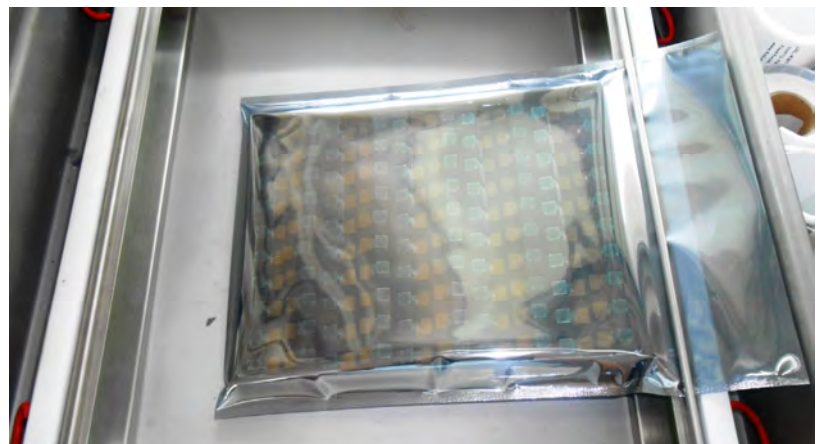



Camera Modules Package Solution

Sealed Vacuum Bag with Labels

1. Model and Description 2. Quantity 3. Shipping Date 4. Caution





Large Order Package Solution

Place Foam Sheets Between Trays



Foam Sheets are Slightly Larger than Trays



Place Foam Sheets and Trays into Box



Foam Sheets are Tightly Fitting Box





Small Order Package Solution

Place Foam Sheets and Trays into Small Box



Foam Sheets are Nicely Fitting the Small Box



Package in Small Box for Shipment



Place Small Boxes into Larger Box





CMOS CAMERA MODULES



your BEST camera module partner

Carbon Box Package Solution

Seal the Carbon Box

Final Package Labelled Box



Carbon Box Ready for Shipment

1. Delivery Address and Phone No.
2. Box No. and Ship Date
3. Fragile Caution



www.KaiLapTech.com sales@KaiLapTech.com Tel: (852) 6908 1256 Fax: (852) 3017 6778

All rights reserved @ Kai Lap Technologies Group Ltd. Specifications subject to change without notice.



Sample Order Package Solution

Place Sample into Small Anti-Static Bag



Place Connectors into Small Ant-Static Bag



Sample Labels on the Small Bag

1. Camera Module or Connector Model
2. Shipping Date and Quantity
3. Caution





Connectors Large Order Package Solution

Connectors in a Wheel



Label Connectors in the Wheel



The Wheel is Perfectly Fitting the Box



Connectors Box Ready for Shipment





Company Kai Lap Technologies (KLT)

Kai Lap Technologies Group Limited. (KLT) was established in 2009, a next-generation technology driven manufacturer specialized in research, design, and produce of audio and video products. KLT is occupying 20,000 square feet automated plants with 100 employees of annual throughput 30,000,000 units cameras.

KLT provides OEM, ODM design, contract manufacturing, and builds the camera products. You may provide the requirements to us, even with a hand draft, our sales and engineering work together to meet your needs. We consider ourselves your last-term partner in developing practical and innovative solutions.

Our team covers everything from initial concept development to mass produced product. KLT specializes in customized camera design, raw material, electronic engineering, firmware/software development, product testing, and packing design. Our experienced strategic supply systems offer a robust and dependable manufacturing capacity for orders of various sizes.

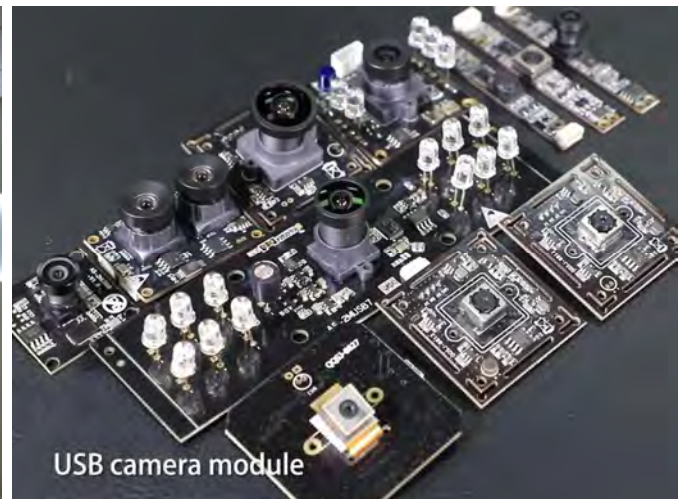

Limited Warranty

KLT provides the following limited warranty if you purchased the Product(s) directly from KLT company or from KLT's website, www.KaiLapTech.com. Product(s) purchased from other sellers or sources are not covered by this Limited Warranty. KLT guarantees that the Product(s) will be free from defects in materials and workmanship under normal use for a period of one (1) year from the date you receive the product ("Warranty Period").

For all Product(s) that contain or develop material defects in materials or workmanship during the Warranty Period, KLT will, at its sole option, either: (i) repair the Product(s); (ii) replace the Product(s) with a new or refurbished Product(s) (replacement Product(s) being of identical model or functional equivalent); or (iii) provide you a refund of the price you paid for the Product(s).

This Limited Warranty of KLT is solely limited to repair and/or replacement on the terms set forth above. KLT is not reliable or responsible for any subsequent events.





CMOS CAMERA MODULES



your BEST camera module partner

KLT Strength

Powerful Factory



Professional Service



Promised Delivery



www.KaiLapTech.com sales@KaiLapTech.com Tel: (852) 6908 1256 Fax: (852) 3017 6778

All rights reserved @ Kai Lap Technologies Group Ltd. Specifications subject to change without notice.